



Cat[®] Advansys[™] Tips and Adapters

The Next Generation
Hammerless G.E.T.

**FOR MAXIMUM
PRODUCTIVITY**

Cat[®] Advansys[™] 130-220 tips and adapters are built specifically for demanding high production applications, moving more material with less machine down time, shift after shift.

The right solution built for the toughest jobs.



BUILT FOR IT.[™]



THE RIGHT SOLUTION BUILT FOR THE TOUGHEST JOBS



1 | UNDERSTAND CAT ADVANSYS FEATURES AND BENEFITS

Optimize the performance of your 988-994 wheel loader or 349-390 hydraulic excavator with Cat Advansys GET. The newest and most robust Cat system delivers the highest productivity and quickest installation and removal times.

Cat Advansys System Benefits Summary:

- **Improved Productivity:**

Exclusive tip and adapter features result in the highest productivity Cat system

- **Enhanced Reliability:**

Strongest, most robust adapters Caterpillar has ever produced

- **Hammerless installation:**

Quickest hammerless tip removal and installation with a 3/4 inch retainer lock that requires no special tools

- **Simplify Installation:**

Integrated retention components mean no more searching for pins or retainers

- **Simplify Retrofitting:**

Easy upgrading because Advansys adapters drop into the same space as K series

- **Simplify Ordering:**

One part number to order when changing a set of tips

Cat Advansys System Performance:

- Exclusive performance features such as tapered tip sides offer less drag and higher productivity
- New and optimized tip shapes put wear material where you need it most

Cat Advansys System Reliability:

- Stronger adapter noses are designed with up to a 50% stress reduction
- Improved adapter nose geometry reduces sliding wear on adapter nose surfaces extending the life of the adapter
- Improved tip shapes shadow the adapter straps and welds for longer adapter life
- Top covers available for double strap adapters and full adapter covers available for high abrasion flush mount adapters

Cat Advansys Hammerless Installation and Removal:

- Half turn of retention locks and unlocks the CapSure retention
- Only a 1/2" or 3/4" breaker bar is required to change the tips
- Retention components come installed in tips



Unlocked



1/2 Turn Locks Tip On

**dependent on application and use*

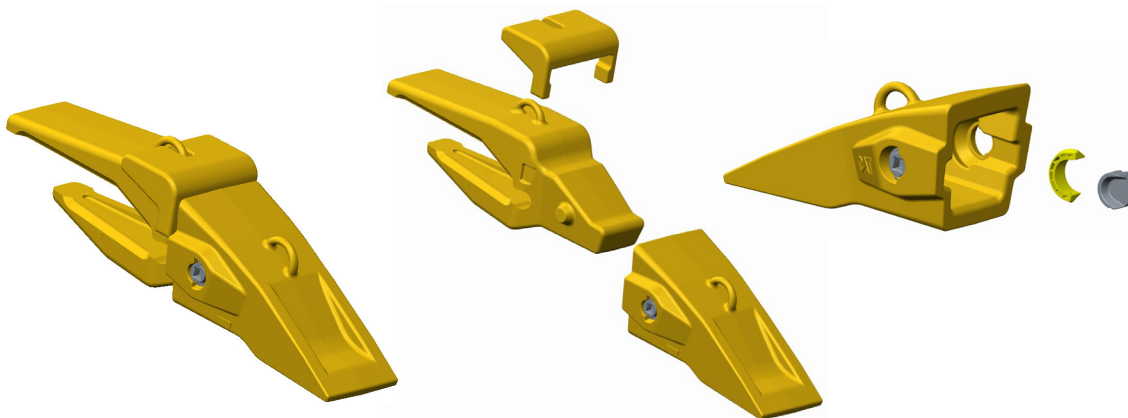

Scan QR Code to see Cat Advansys in action!

2 | SELECT THE RIGHT TIP BASED ON PENETRATION AND WEAR LIFE



Heavy Abrasion - NEW!

A.R.M.
OPTION
AVAILABLE



Heavy Penetration - NEW!



Heavy Duty

A.R.M.
OPTION
AVAILABLE



**General Purpose
Loader**



Coal



Penetration Plus



Penetration

A.R.M.
OPTION
AVAILABLE

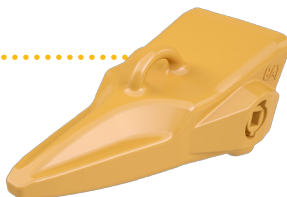

↑
ABRASION RESISTANCE

↓
PENETRATION

Heavy Duty

A.R.M.
OPTION
AVAILABLE



**General Purpose
Excavator - NEW!**



Wide



Penetration Plus



Penetration

A.R.M.
OPTION
AVAILABLE



Spike



Double Spike





3 MACHINE SPECIFIC BENEFITS – WHEEL LOADERS

Wheel Loader customers will see these additional benefits:



- **New Heavy Abrasion and Heavy Penetration tips have longer usable life because they stay sharper through the full life of the entire tip**

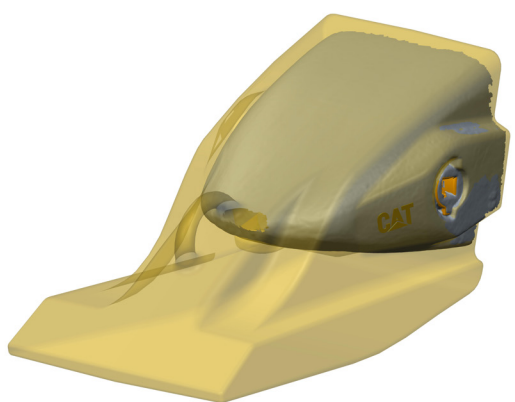

X220 Heavy Abrasion Tip
72% Available Wear Material

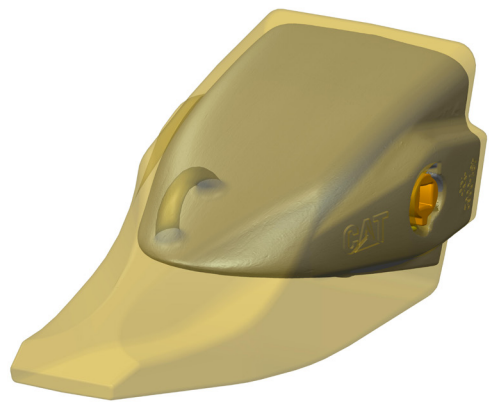

X220 Heavy Penetration Tip
60% Available Wear Material

- **Top covers available for double strap adapters and full adapter covers available for high abrasion flush mount adapters**

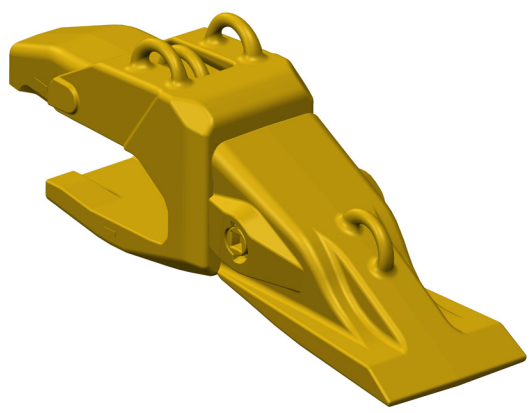
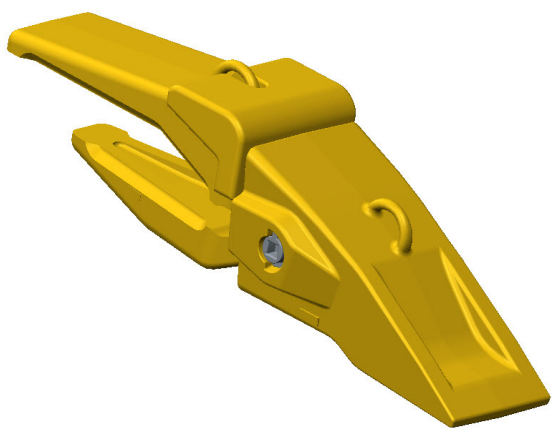

3 MACHINE SPECIFIC BENEFITS – HYDRAULIC EXCAVATORS

Hydraulic Excavator customers will see these additional benefits:



- **Up to a 15% productivity increase in trenching applications due to improved tip and adapter geometry**
- **Exclusive performance features such as tapered tip sides reduce drag and increase productivity**
- **Increased fuel efficiency**

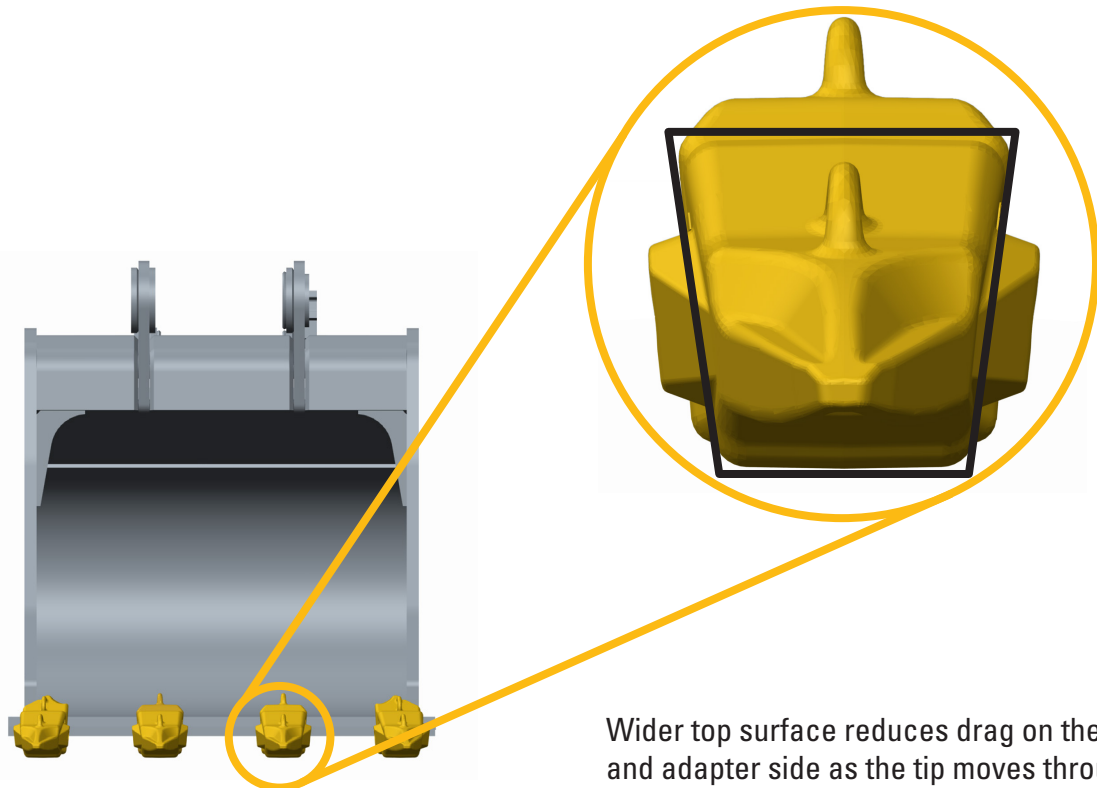

Wider top surface reduces drag on the tip and adapter side as the tip moves through the soil. Reduced side drag results in less force required to move the hex bucket through the soil.

Cat Advansys Tips and Adapters



**THE RIGHT SOLUTION
BUILT FOR THE
TOUGHEST JOBS**

BUILT FOR IT.™

PEHJ0508

© 2015 Caterpillar • All Rights Reserved • Printed in USA
CAT, CATERPILLAR, BUILT FOR IT, their respective logos, "Caterpillar Yellow" and the "Power Edge" trade dress, as well as corporate and product identity used herein, are trademarks of Caterpillar and may not be used without permission.

